



CZĘSTOTLIWOŚĆ ROBÓCZA: Wykrywacz jest skonfigurowany do pracy z podstawową częstotliwością roboczą 9,3 KHz.

Read the instruction manual for more detailed information  
Przeznaczaj instrukcję obsługi, aby uzyskać bardziej szczegółowe informacje  
Leia o manual de instruções para informações mais detalhadas



www.minelab.com



Guía de Inicio Rápido

Quick Start Guide Skrócona Instrukcja Obsługi



Unpack  
Abra o detector

Rozpakuj

Insert Batteries  
Coloque as baterias

Włóż baterie

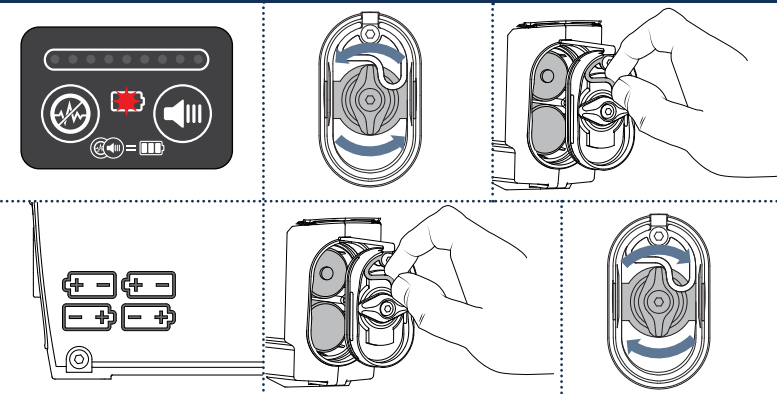
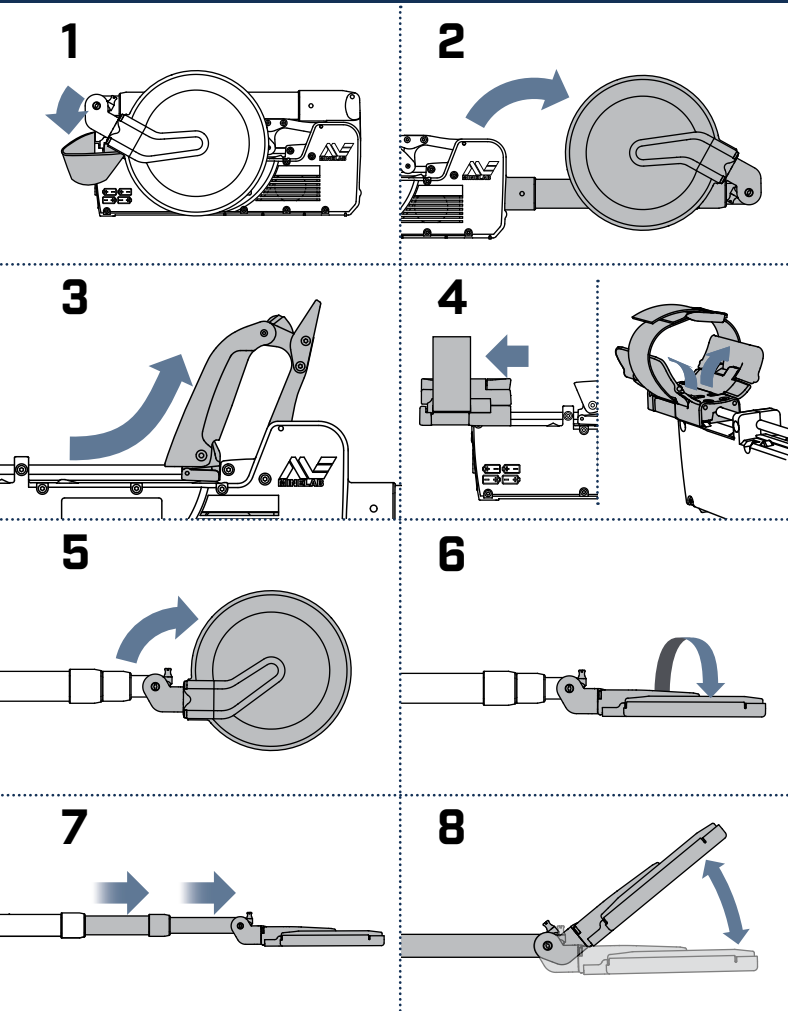

Connect Headphones  
Conecte os fones de ouvido

Podłącz słuchawki

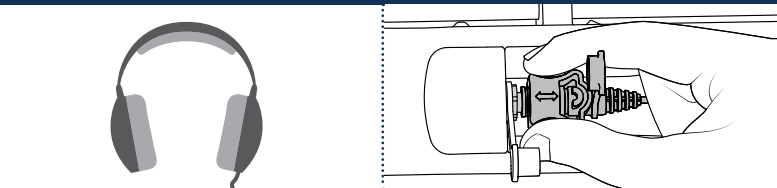

Pack Up  
Feche o detector

Spakuj

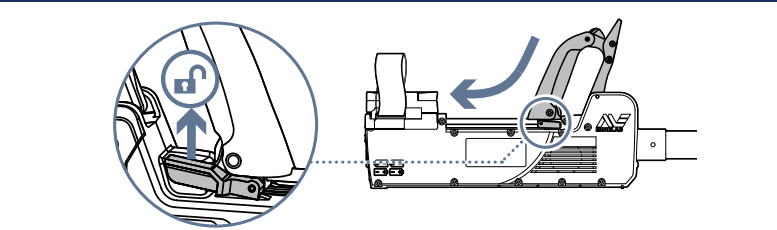

## Setup

## Ustawienie

## Ajustes

### 1

Set default Sensitivity  
Ustaw czułość jako  
Domyślną  
Ajustar à Sensibilidade  
padrão

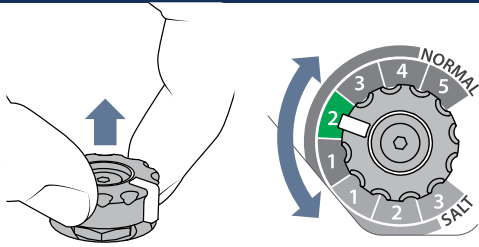

### 2

Turn On  
Włączanie  
Ligar o Detector

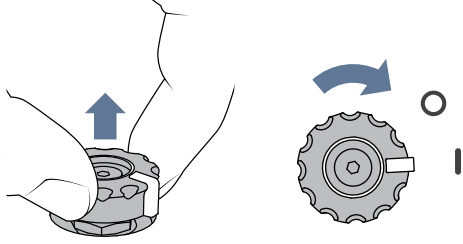

### 3

Noise Cancel  
Tłumienie hałasu  
Cancelar Ruído

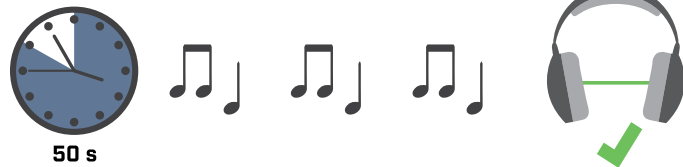

### 4

Set Threshold  
Ustaw próg  
Ajustar o Tom Limiar



### 5

Ground Balance  
Równowaga gruntu  
Realizar o Equilíbrio de Solo

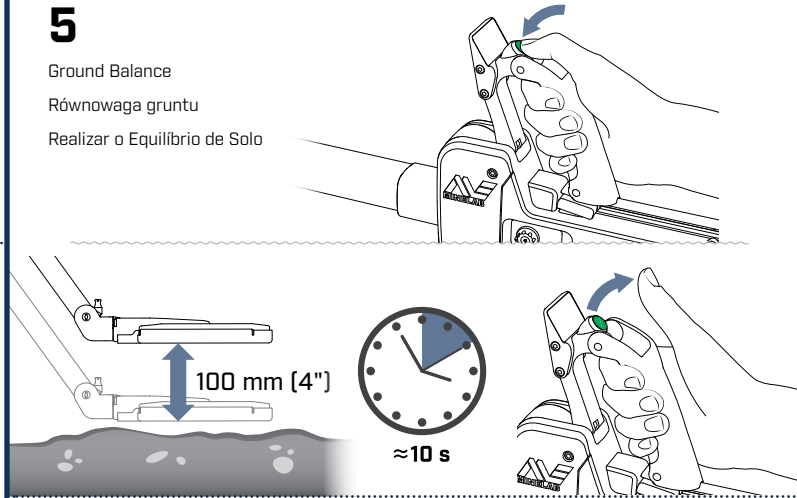

### 6

Start Detecting  
Rozpocznij wykrywanie  
Começar a Detecção

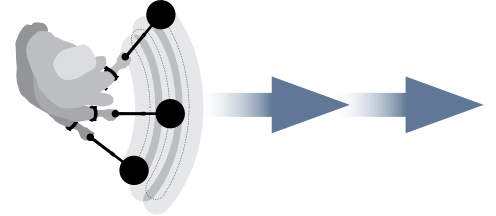

## Detecting Basics

## Podstawy Wykrywania

## Detecção Básica

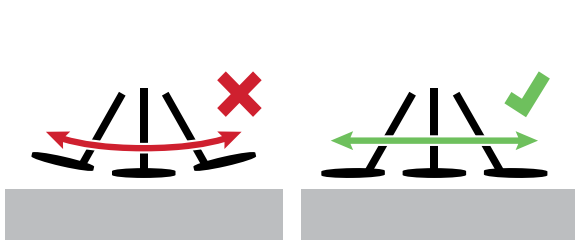

Sweep level  
Poziom ruchów  
zamiatających  
Nível da varredura

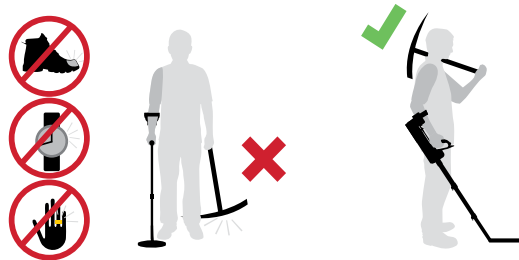

Keep metal away  
from coil  
Trzymaj metal z  
daleka od cewki  
Mantenha metais  
afastados da bobina



Sweep slowly  
Powolne ruchy  
zamiatające  
Varra lentamente

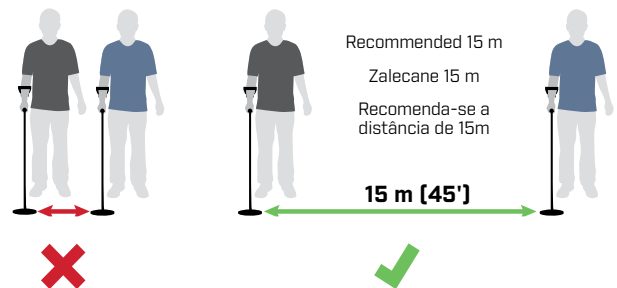

Recommended 15 m  
Zalecane 15 m  
Recomenda-se a  
distância de 15m

Move apart  
Oddalają się  
od siebie  
Afaste-se  
de outros  
detectores



Overlap sweep  
Powolne ruchy  
zamiatające  
Sobreponha a varredura

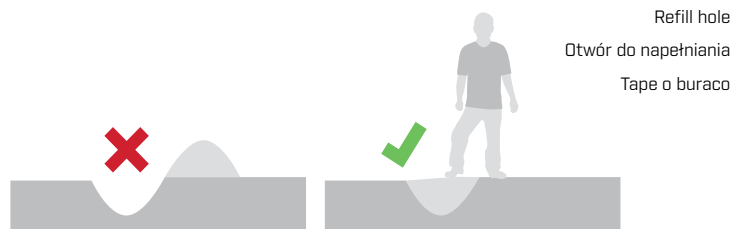

Refill hole  
Otwór do napełniania  
Tape o buraco